

M12 male 0° / RJ45, 45° up, shielded, Ethernet

PUR 2x2xAWG22 shielded gn UL/CSA+dragchain 1,5m

Ethernet CAT5

The resistance to aggressive media should be individually tested for your application. Further details on request.

Male straight – male 45° on top

M12 – RJ45, 4-pole

D-coded

shielded

8-pole partly used

Transmission properties with channel transmission up to 100 m

Further cable lengths on request.

Plastic housings with good resistance against chemicals and oils.

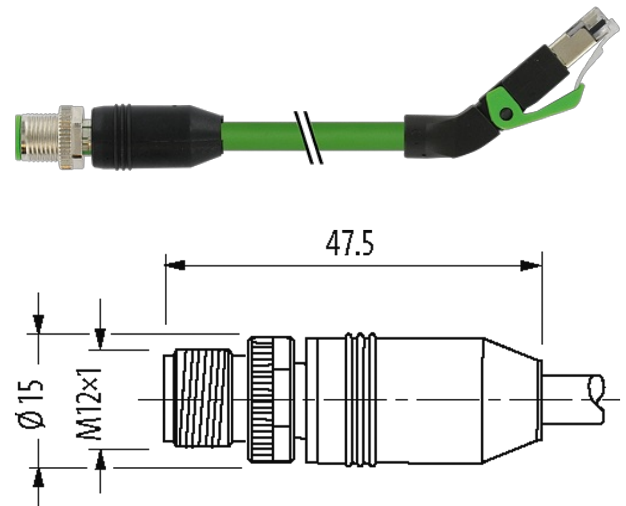
[Link to Product](#)**Illustration**

Product may differ from Image

Approvals

* only for products with UL/CSA approved cable

More Info



Form

Form 44721

General data

Standards DIN EN 61076-2-101 (M12)

Pollution Degree 3

Temperature range -25...+85 °C, depending on cable quality

Cables	
No./diameter of wires	2x 2x 0.34 mm ²
Wire isolation	PE (wh, ye, bl, or)
C-track properties	3 Mio.
Jacket Color	green
Material (jacket)	PUR (UL/CSA)
Outer Ø	6.7 mm ±5%
Bend radius (moving)	12x outer Ø
Temperature range (fixed)	-40...+80 °C
Temperature range (mobile)	-30...+70 °C
Cable identification	796
Approval (cable)	UL (AWM-Style 20233/11602), CSA; CE
Cable weight [g/m]	69,3
Material (wire)	Cu wire, bare
Resistor (core)	max. 55 Ω/km (20 °C)
Diameter (core)	2x 2x AWG22
Material (wire isolation)	PE
Wire-Ø incl. isolation	1.4 mm ±5%
Color/numbering of wires	wh, ye, bl, or
Shield	yes
	min. 85%
Material (jacket)	PUR
Outer-Ø (jacket)	6.7 mm ±5%
Color (jacket)	green
thermal resistance	flammwidrig nach UL 1581 Section 1060 (FT1), Section 1061 (cable flame), Section 1080 (VW-1) / IEC 60332-1-2
Nominal voltage	300 V
Temperature range (fixed)	-40...+80 °C
Temperature range (mobile)	-30...+70 °C
Bend radius (fixed)	5x outer Ø
Bend radius (moving)	12x outer Ø
No. of bending cycles (C-track)	max. 3 Mio. (25 °C)
Traversing distance (C-track)	max. 5 m (horizontal)
Travel speed (C-track)	max. 3.3 m/s
Acceleration (C-track)	max. 2 m/s ²
Technical Data	
Operating voltage	max. 60 V DC
Operating voltage (only UL listed)	max. 30 V DC
Rated surge voltage	1.0 kV
Operating current per contact	max. 1.5 A (20 °C)
Material group	IEC 60664-1, category I
Transfer parameters	CAT5, Class D (ISO/IEC 11801:2002), (EN 50173-1)
Transfer rate	up to 100 Mbit/s full duplex
Coding	M12, D-coded
Locking of ports	Screw thread (M12x1 mm) recommended torque 0.6 Nm, self-securing
Compression gland	M12 (SW13)
Protection	IP66K, IP67 (M12) - IP20 (RJ45)

Locking material	Zinc die casting, matte nickel plated
Material	PUR
suitable for corrugated tube (internal Ø)	without

Commercial data

country of origin	DE
customs tariff number	85444210
EAN	4048879373623
eClass	27061801
Packaging unit	1

Sketch

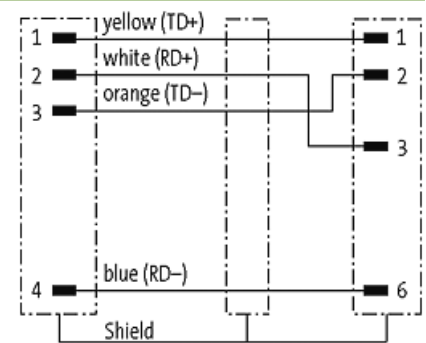

Male

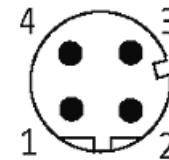

Male



Product may differ from Image